

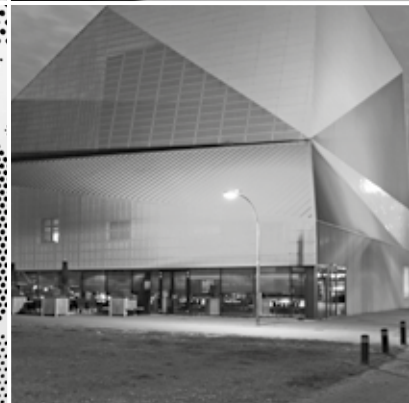

EXPERTS IN
PERFORATED METAL

architecture

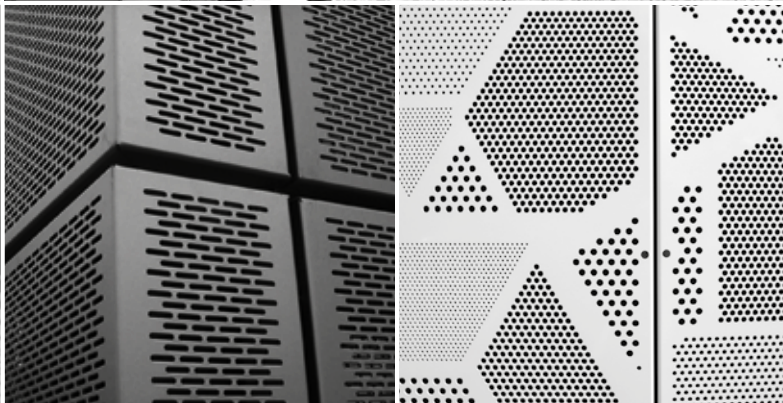
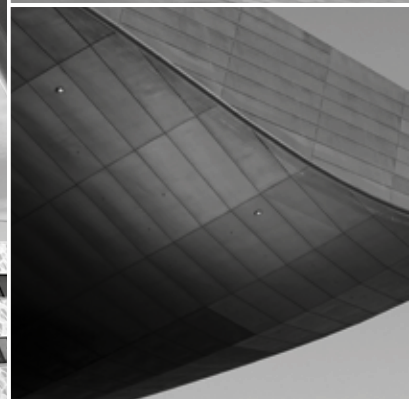
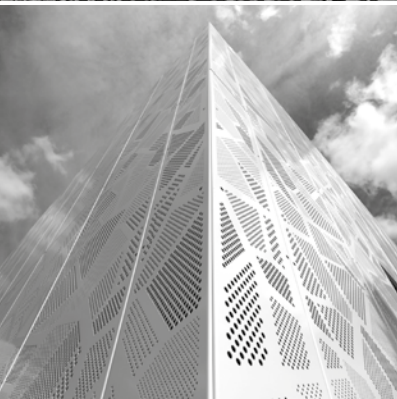

INNOVATION beginnt mit einer IDEE.
innovation begins with an idea.

Gegründet im Jahre 1895, ist die Dillinger Fabrik gelochter Bleche GmbH seit 125 Jahren auf dem Gebiet der Herstellung von Lochblechen tätig.

Modernste Fertigungsanlagen und eine optimierte inner- und außerbetriebliche Logistik garantieren dabei eine optimale qualitative und termingerechte Umsetzung. Begleiten Sie uns in eine moderne Architekturwelt, in der Lochblech eine tragende- und designorientierte Rolle spielt. Wir realisieren ihre Vorstellungen.





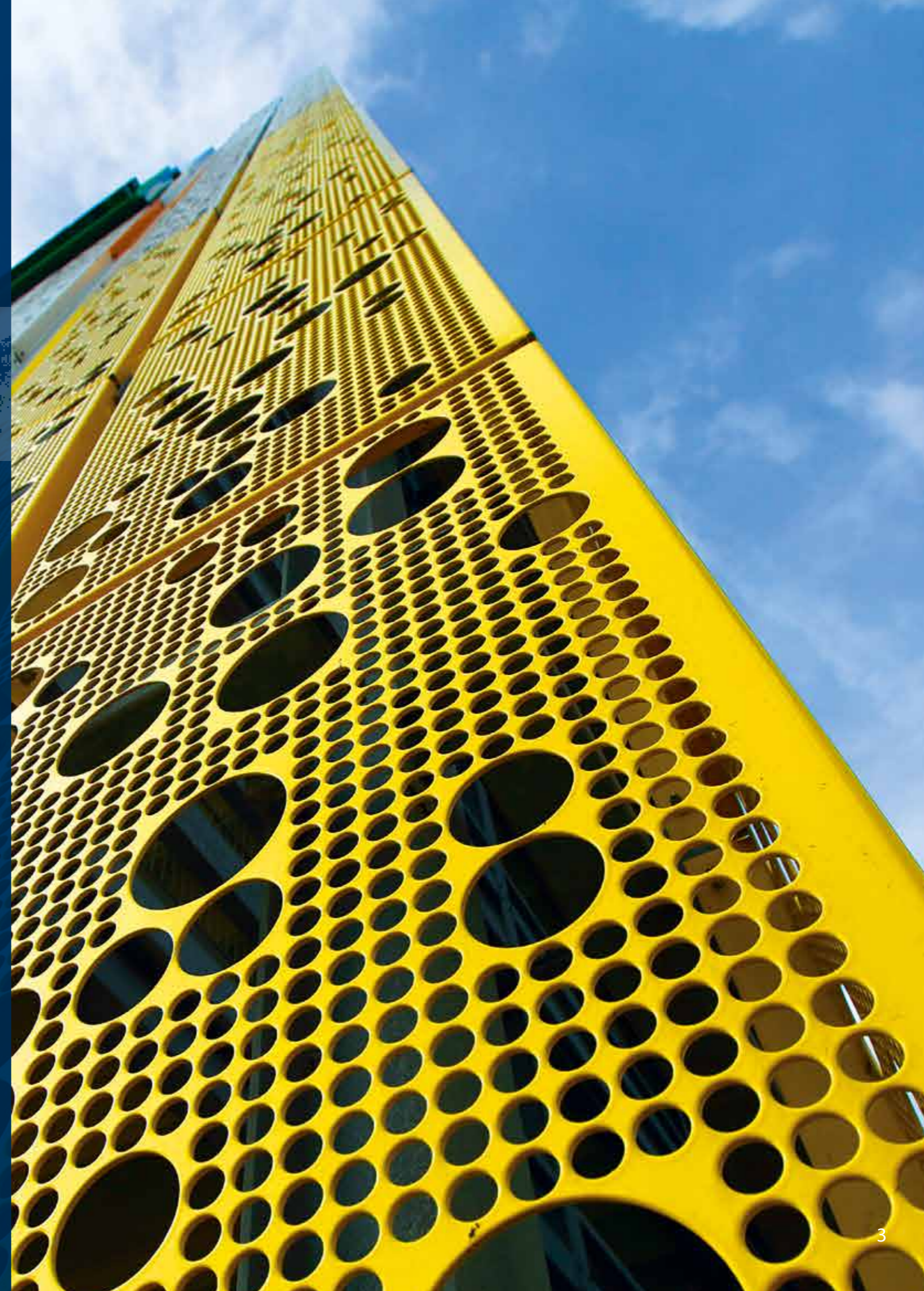

Founded in 1895, Dillinger Fabrik gelochter Bleche GmbH has more than 125 years experience in the field of manufacturing and processing perforated sheets.

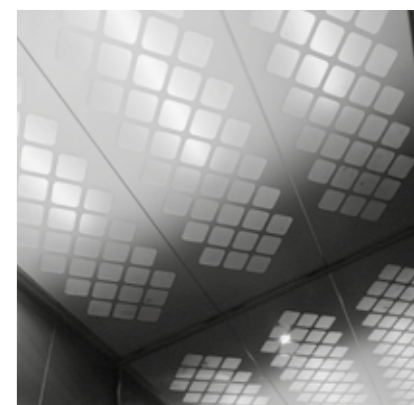
State of the art production facilities and optimised internal- and external logistics guarantee the best qualitative and on time delivery for your ideas and projects. Follows us into a world of modern architecture with design-orientated and functional perforated metal solutions.

We realize your ideas.





	04	Fassaden facades
	32	Parkhäuser car park
	42	DesignPERF®
	50	Audi Fassade Audi facade
	56	Innenarchitektur interior design
	66	Sichtschutz und Balkone
	68	Unterkonstruktionssysteme subsystems fixing



INNOVATIV,
MODERN, ZEITGEMÄSS

FASSADEN

Die Fassade ermöglicht dem Architekten ästhetische und funktionelle Elemente zu vereinen und dem Bauwerk seine Einzigartigkeit zu verleihen.

Die Konstruktion unter energetischen Aspekten, unter Verwendung zeitgemäßer Materialien sind Voraussetzung bei modernen Bauvorhaben. Fassadenlösungen aus Lochblech unterstützen in idealer Weise die Anforderungen von Architekten, Ingenieuren und Designern. In Zeiten ressourcenschonenden Umgangs mit Energie und Rohstoffen, ergeben sich insbesondere bei der Beschattung, sowie der aktiven Steuerung des Tageslichteinfalls, interessante Anwendungsgebiete für Lochbleche, welche Ästhetik, Funktion und Wärmehaushalt optimal in Einklang bringen können.

FAÇADES

The façade allows the architect to combine aesthetic and functional elements and give the building its uniqueness.

The construction under energetic aspects, using contemporary materials, is a prerequisite for modern building projects. Facade solutions made of perforated sheeting ideally support the requirements of architects, engineers and designers.

In times of resource-conserving use of energy and raw materials, there are interesting areas of application for perforated sheeting, especially in shading and active control of daylight incidence, which can optimally harmonise aesthetics, function and heat balance.

Neue kreative Ansätze wie beispielsweise DesignPerf® bieten höchste Individualisierungsmöglichkeiten bei gleichzeitig werthaltiger, dauerhafter und erprobter Technologie.

Die Dillinger Fabrik gelochter Bleche unterstützt Sie bei der Lösungsfindung mit einem erfahrenen Team mehrsprachiger Ingenieure.

New creative approaches, such as DesignPerf®, offer the highest individualization possibilities with at the same time valuable, durable and proven technology.

The Dillinger Fabrik gelochter Bleche supports you in finding solutions with an experienced team of multilingual engineers.



THEATER UND KONGRESS-
ZENTRUM AGORA IN LELYSTAD

Architect: B+M / UNStudio

Material: perforated steel

Completion: 2010

CORPORATE ARCHITECTUR in neuer Dimension
corporate architecture in a new dimension

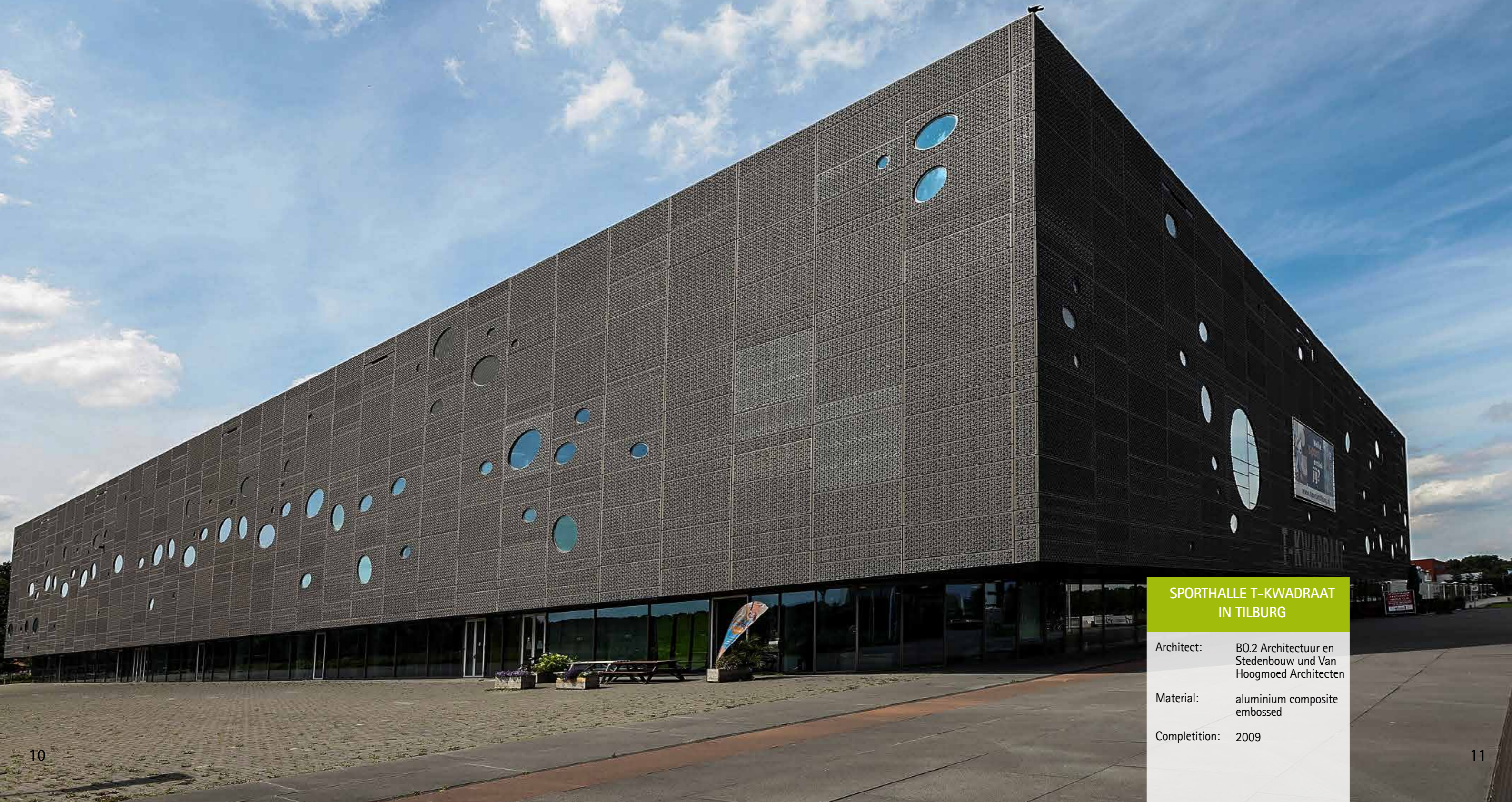

**SPORTHALLE T-KWADRAAT
IN TILBURG**

Architect: BO.2 Architectuur en
Stedenbouw und Van
Hoogmoed Architecten

Material: aluminium composite
embossed

Completion: 2009



MUSÉE DES CONFLUENCES
IN LYON

Architect: Coop Himmelb(l)au
Material: perforated and non
perforated stainless
steel sheets
Completion: 2014





**CHRU NANCY
CENTRE HOSPITALIER
REGIONAL UNIVERSITAIRE**

Architect: Art + Build Architekt
Brussels

Material: perforated 3mm
aluminium sheets,
powder coated

Completion: 2019





INSELHALLE

Architect : Auer - Weber BDA
 Material: perforated and non-perforated aluminum sheets powder coated
 Completion: 2015



DIE 5000 TONNEN Gewitterwolke
the 5000 ton thundercloud

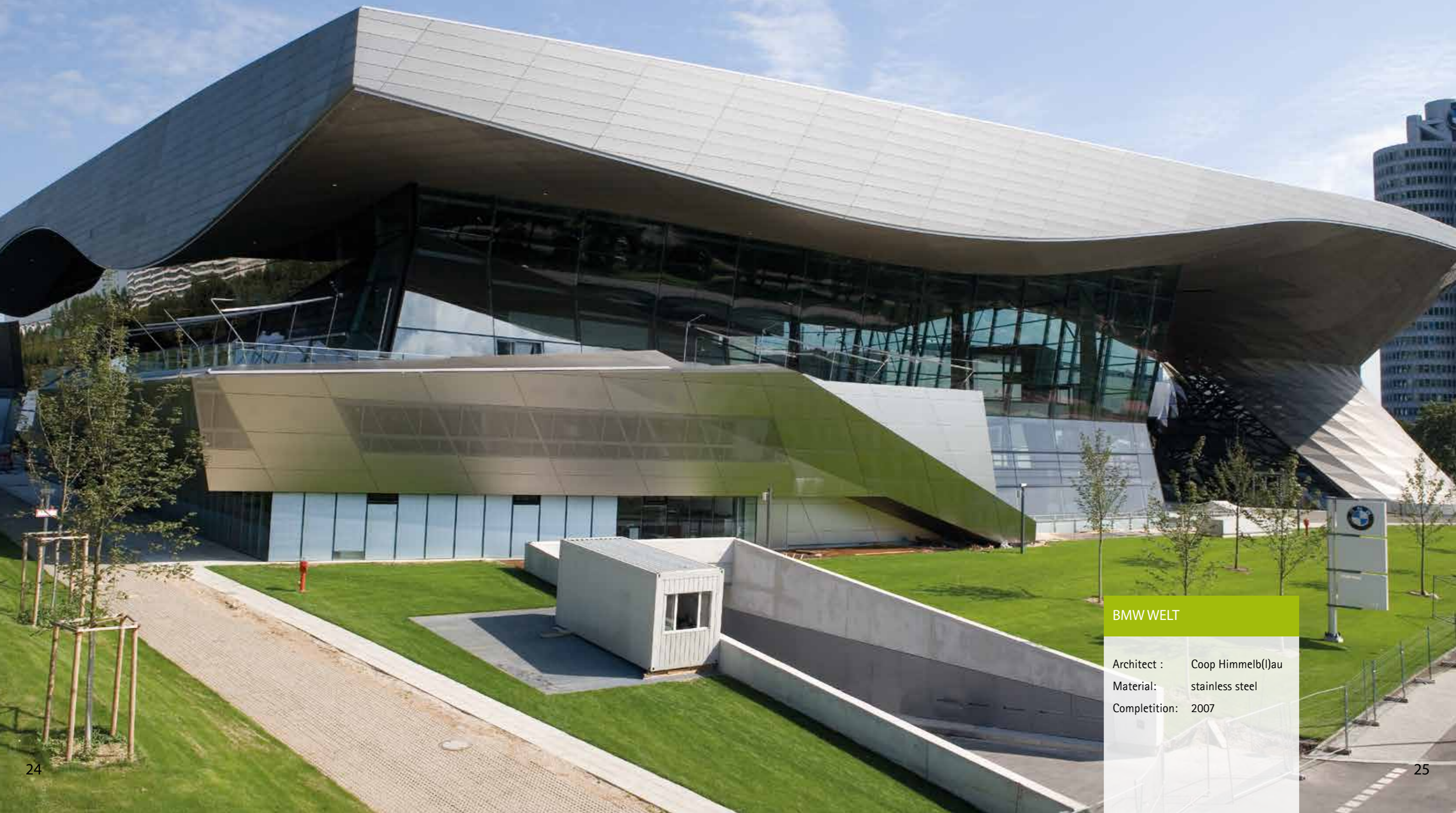

BMW WELT

Architect : Coop Himmelb(l)au
Material: stainless steel
Completion: 2007

CORPORATE ARCHITECTUR in neuer Dimension
corporate architecture in a new dimension

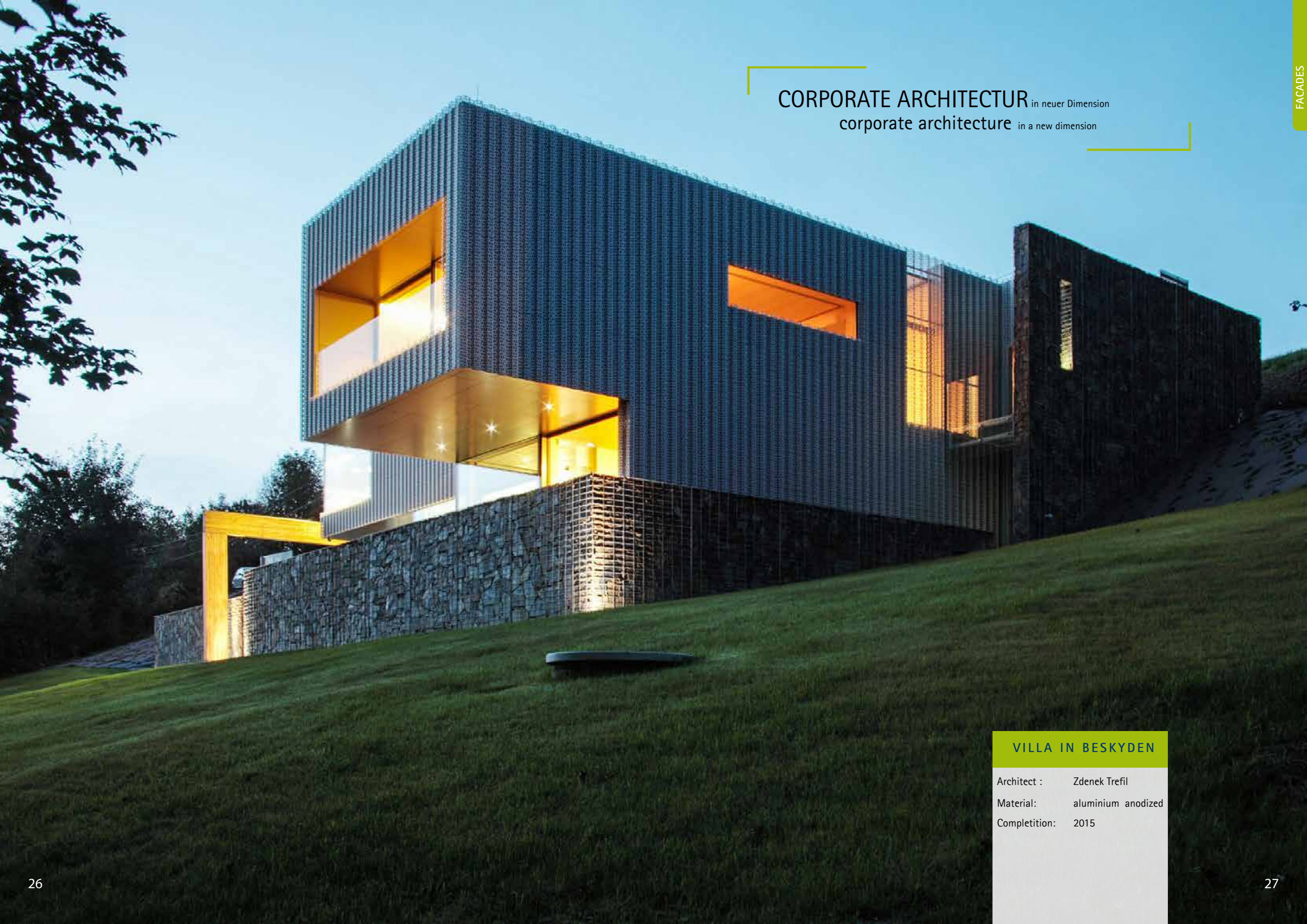

VILLA IN BESKYDEN

Architect : Zdenek Trefil
Material: aluminium anodized
Completion: 2015

VILLA IN BESKYDEN



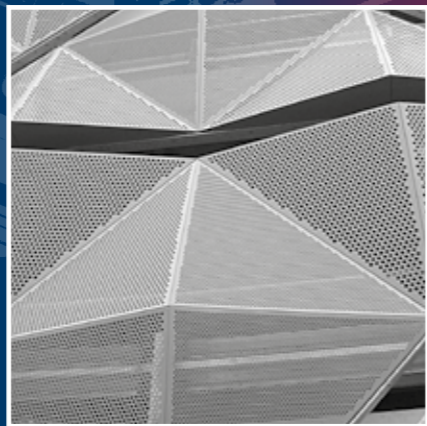
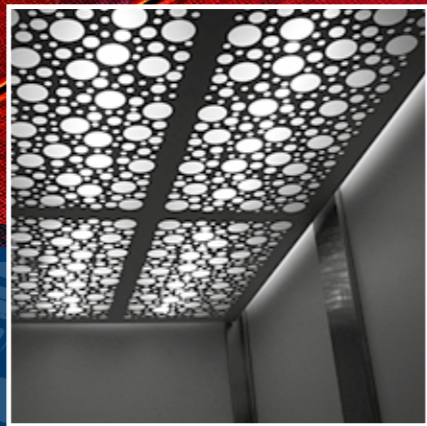
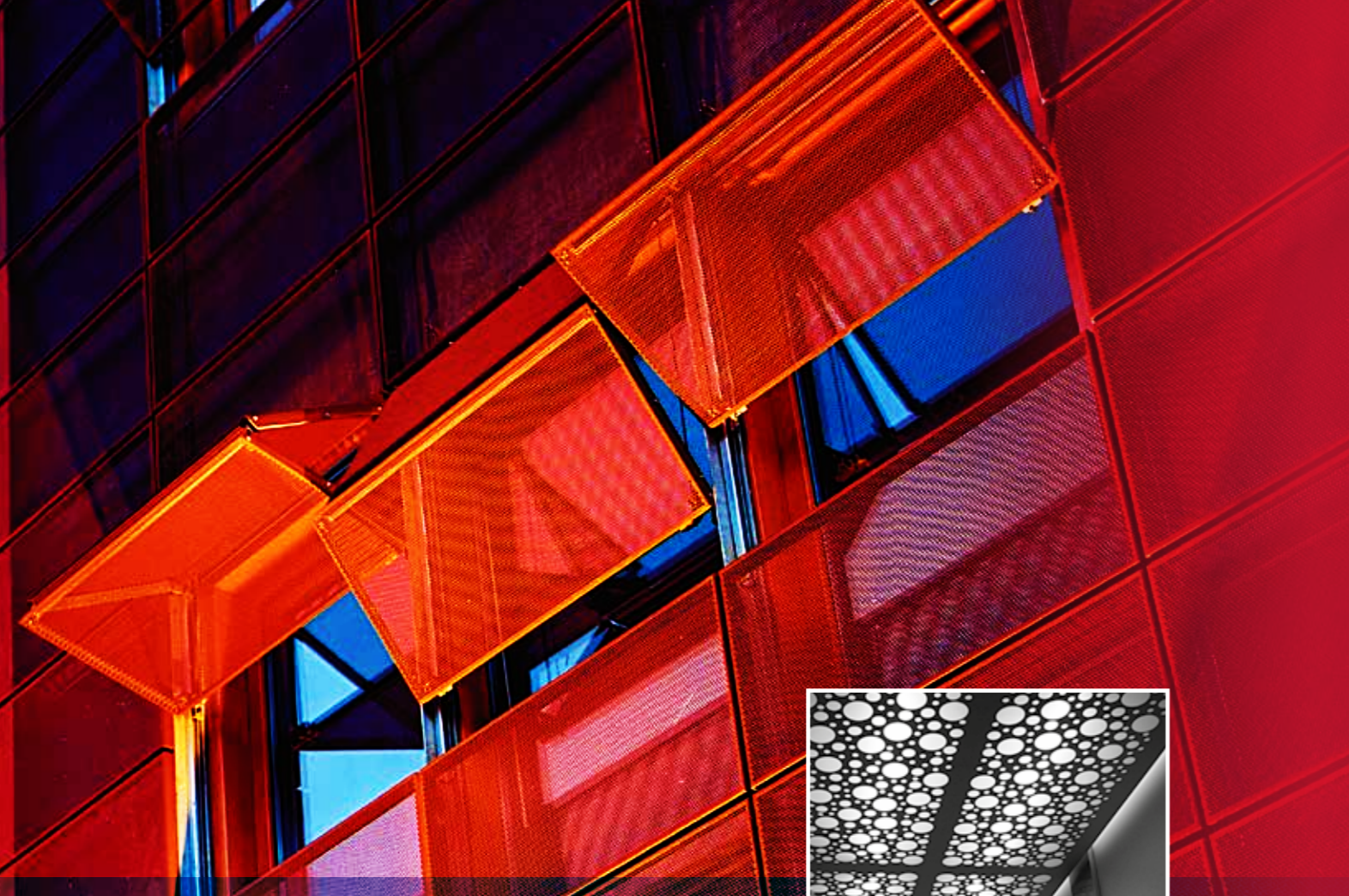

THE FUTURE
IS NOW.



FUTURISTISCHEWIRKENDE
WAHRZEICHEN

Parkhäuser

Expandierende Städte und eine damit verbundenen Zunahme des individuellen Verkehrs, erfordern eine ständig wachsende Zahl an nutzbaren Parkflächen. Um möglichst platzsparend und kostengünstig Parkmöglichkeiten zu gestalten bieten mehrstöckige Parkhäuser in vielen urbanen Ballungszentren die einzige Lösung. Eine ausreichende Durchlüftung muß hierbei unbedingt gesichert sein. Dies ist nur mit einer luftdurchlässigen Gebäudefassade möglich. Unter diesen technischen Voraussetzungen bietet sich eine Lochblechfassade an. Bei der ästhetische Gestaltung der Außenfassade sind der Phantasie keine Grenzen gesetzt.

Expanding cities and the associated increase in individual traffic require a constantly growing demand for usable parking spaces. Multi-storey car parks are the only solution in many urban agglomerations in order to make parking as space-saving and cost-effective as possible. Sufficient ventilation must be ensured. This is only possible with an air-permeable building facade. Under these technical conditions, a perforated sheet metal façade is an ideal solution. There are no limits to the imagination when it comes to the aesthetic design of the exterior façade.

KREATIVITÄT braucht PROFESSIONALITÄT
creativity needs professionalism

**CAR PARK HOOFDORP
IN NETHERLAND**

Builder: Huber Car Park systems
Material: perforated galvanized
steel sheets
Completion: 2011



**CAR PARK GOUDA
IN THE NETHERLANDS**

Builder:  Huber Car Park systems
Material: Dx51 D+Z, Round hole
in staggered rows
Completion: 2014

Original Foto



Konvertiertes Foto mit Design Perf Software



DESIGN PERF



Mit dem geschützten Prozess Design PERF© hat die Dillinger Fabrik gelochter Bleche, ein Verfahren ins Sortiment genommen, bei dem Bildmotive oder Grafiken durch Perforation, auf Blechbauteile übertragen werden können. Mit verschiedensten Perforationsanlagen und einer speziell entwickelten Software, ist es möglich Grafiken auf Einzelbleche der Größe 500 x 500 mm bis 2000 x 6000 mm, zu stanzen. Durch Segmentierung des Motives, sind der Abbildung im Bezug auf die Größe nahezu keine Grenzen gesetzt. Somit ist es möglich ganze Fassaden mit Bildmotiven zu realisieren.

Ähnlich wie beim Rasterdruck wird die Grafik durch eine Filterfunktion in Punkten umgewandelt. So werden durch Variation der Lochdurchmesser und Anordnung, Kontraste und Helligkeiten erzeugt.

With the protected process design PERF© the Dillinger Fabrik gelochter Bleche has perforated sheet metal, a procedure is included in the assortment, in which images or graphics through perforation, on the sheet metal components can be transferred. With a wide variety of punching machines and of a specially developed software, it is possible to graphics on single sheets of size 500 x 500 mm up to 2000 x 6000 mm, to be punched. By segmenting the motif, there are almost no limits to the size of the image. It is possible to realize whole facades with picture motives.

Similar to halftone printing, the graphic is represented by a filter function is converted into points. So are achieved by varying the hole diameter and arrangement, contrasts and brightness, that come together to form an image.



Perforiertes eloxiertes Blech



PARKHAUS REGENSBURG

Architect : Manfred Hartwig
Material: anodized perforated aluminium, DesignPerf®
Completion: 2018



DER LANG GESTRECKTE KUBUS
THE ELONGATED CUBE



EURONEWS

Architect: Jakob + MacFarlane
Material: aluminium perforated,
DesignPerf®
Completion: 2015

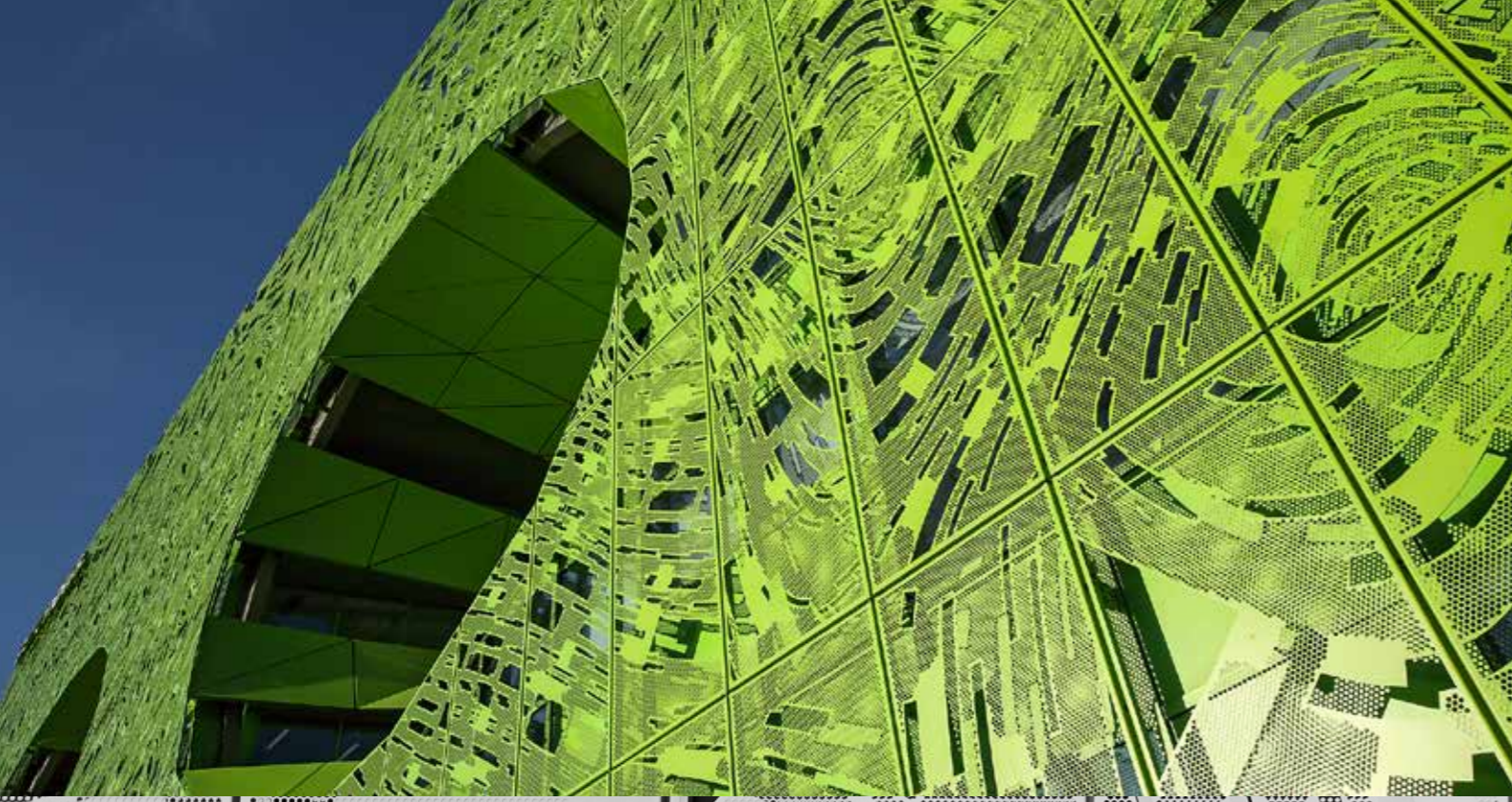

electronews.

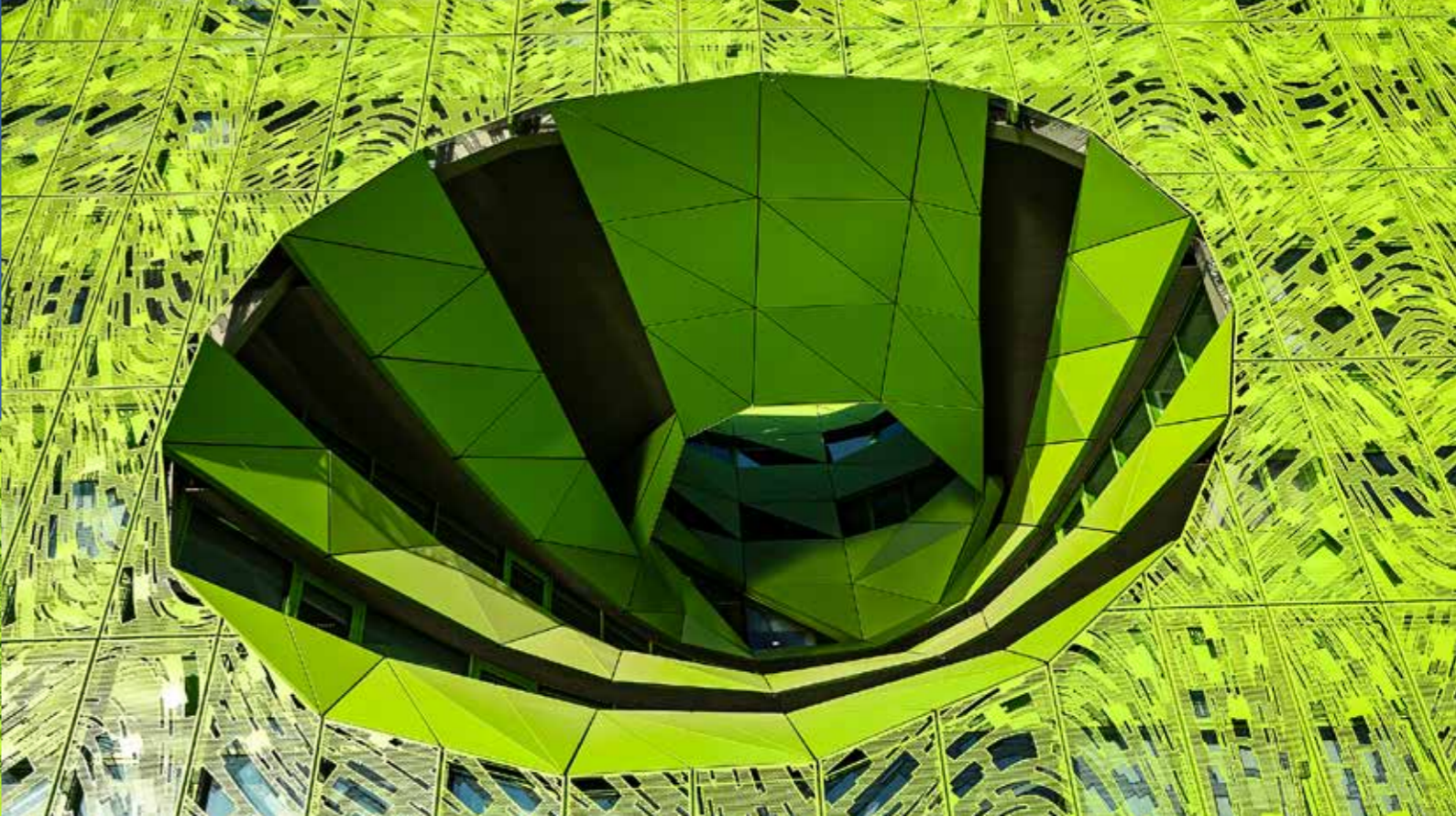
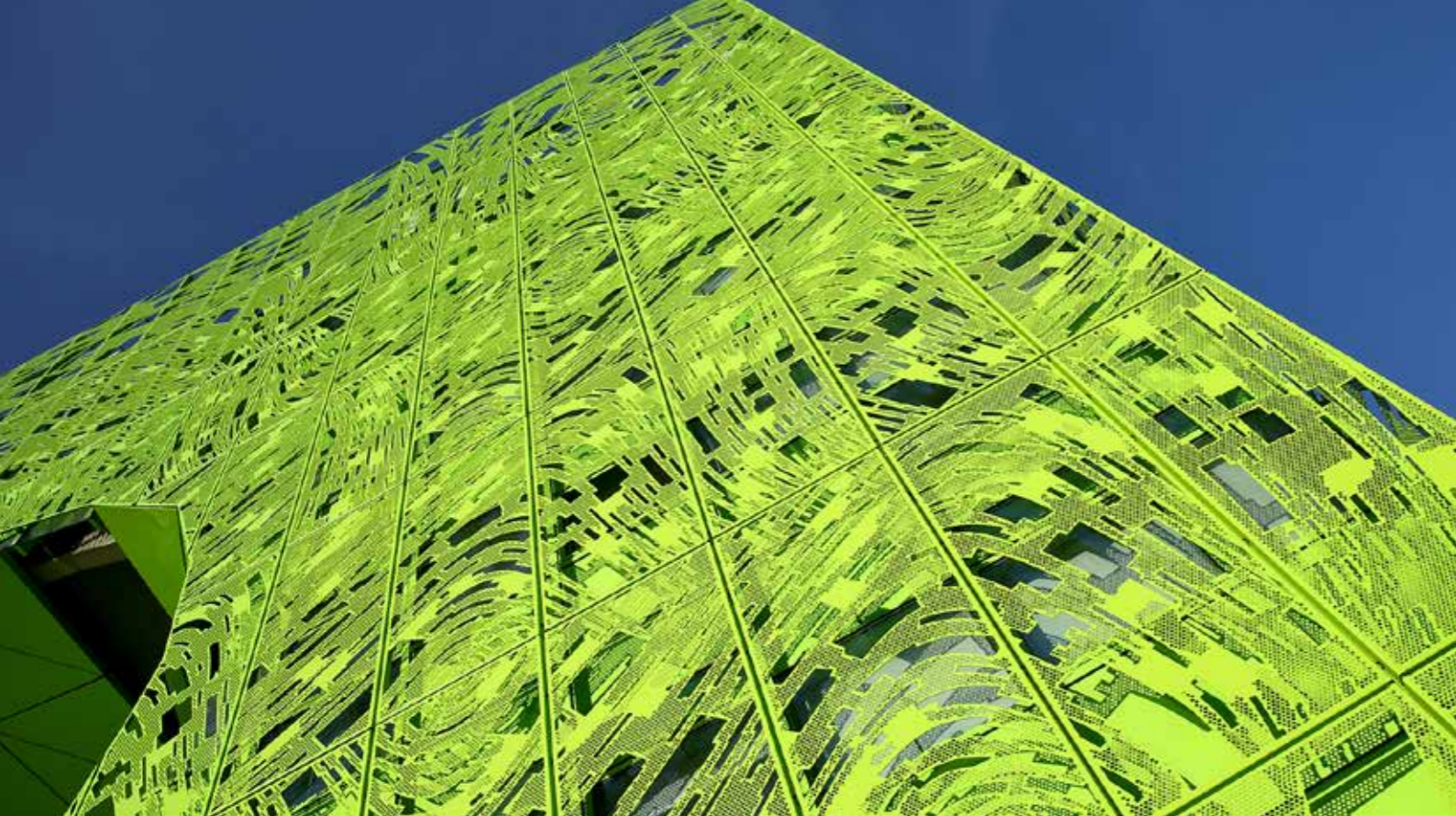

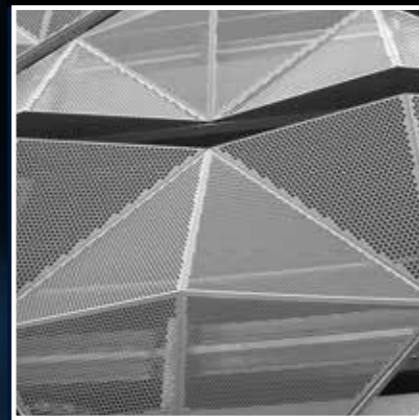
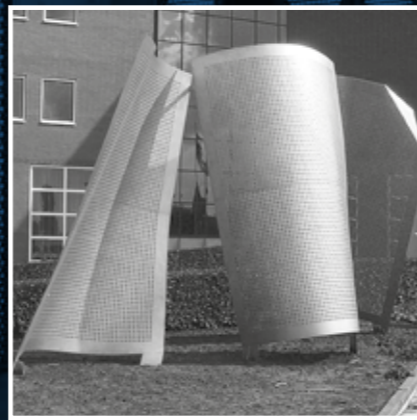

AUDI FASSADEN



Corporate Identity, Dynamik, Transparenz und die Visualisierung des Audi Premium Produktes, waren die Gründe für die Einführung der „Audi Terminal Façade“ im Jahre 2008.

Aluminium als hochwertiger Werkstoff mit edler Oberfläche, gestanzt in einer Sechskantlochung mit versetzten Reihen, sind wesentliche Gestaltungsmerkmale der neuen Präsentationsgebäude.

Die aufgesetzte, belüftete Façade, mit einer offenen Fläche von 50 %, ist horizontal gekantet und hell Silber eloxiert (E6EV1). Die Abmessungen der Wabenlochung betragen 61,5 mm x 26 mm.

Die dreidimensionale Struktur wirkt luftig und zugleich solide.

Die Dillinger Fabrik gelochter Bleche liefert ihnen ihre Terminal-Façade auf Wunsch mit Zubehör wie Unterkonstruktion, Zahnleisten und Laibungsverkleidungen.

Weltweit wurden bereits mehr als 250 Projekte mit einer Gesamtfläche von größer 150.000m² realisiert.

Corporate identity, dynamics, transparency and the visualization of the Audi premium product were the reasons for the introduction of the „Audi Terminal Façade“ in 2008.

Aluminium as a high-quality material with a noble surface, punched in a hexagonal perforation with staggered rows, are essential design features of the new presentation buildings.

The ventilated façade, with an open area of 50 %, is horizontally berded and light silver anodized (E6EV1). The dimensions of the honeycomb perforation are 61.5 mm x 26 mm.

The three-dimensional structure appears airy and solid at the same time.

On request, Dillinger Fabrik gelochter Bleche can supply your terminal façade with accessories such as substructure, toothed strips and soffit cladding.

More than 250 projects with a total area of more than 150,000m² have already been realised worldwide.



AUDI SHOWROOM

Architect: Allmann Sattler Wappner

Material: honeycomb perforated, anodized aluminium sheets

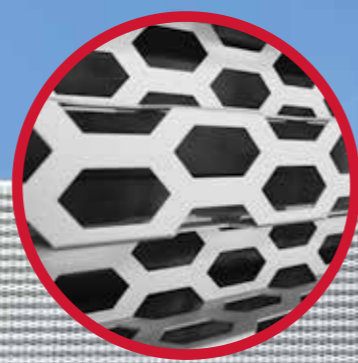
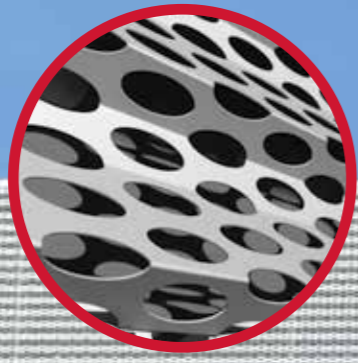
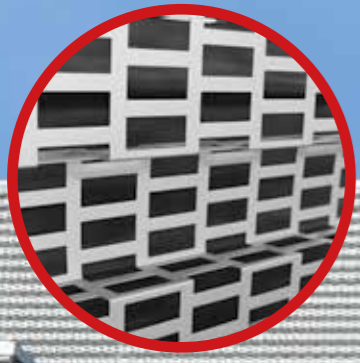



ELEGANZ UND ÄSTHETIK
MIT LOCHBLECH

INTERIOR DESIGN

Auch im Interior-Design wird Lochblech wegen seiner Vielseitigkeit und Funktionalität (Schall und Sonnenschutz) immer häufiger eingesetzt. Dabei zeichnet es sich nicht nur durch Eleganz und Ästhetik, sondern vor allem durch Langlebigkeit und Nachhaltigkeit aus.

Vielseitige Einsatzzwecke wie z.B. Möbel, Treppengeländer, Beschattungsanlagen, Trenn- und Wandverkleidungen, bieten Architekten und Endkunden alle Möglichkeiten zur individuellen Gestaltung.

Perforated sheeting is also increasingly being used in interior design because of its versatility and functionality (sound and sun protection). It is characterised not only by elegance and aesthetics, but above all by durability and sustainability.

A wide range of applications such as furniture, stair railings, shading systems, partition and wall cladding offer architects and end customers all possibilities for individual design.

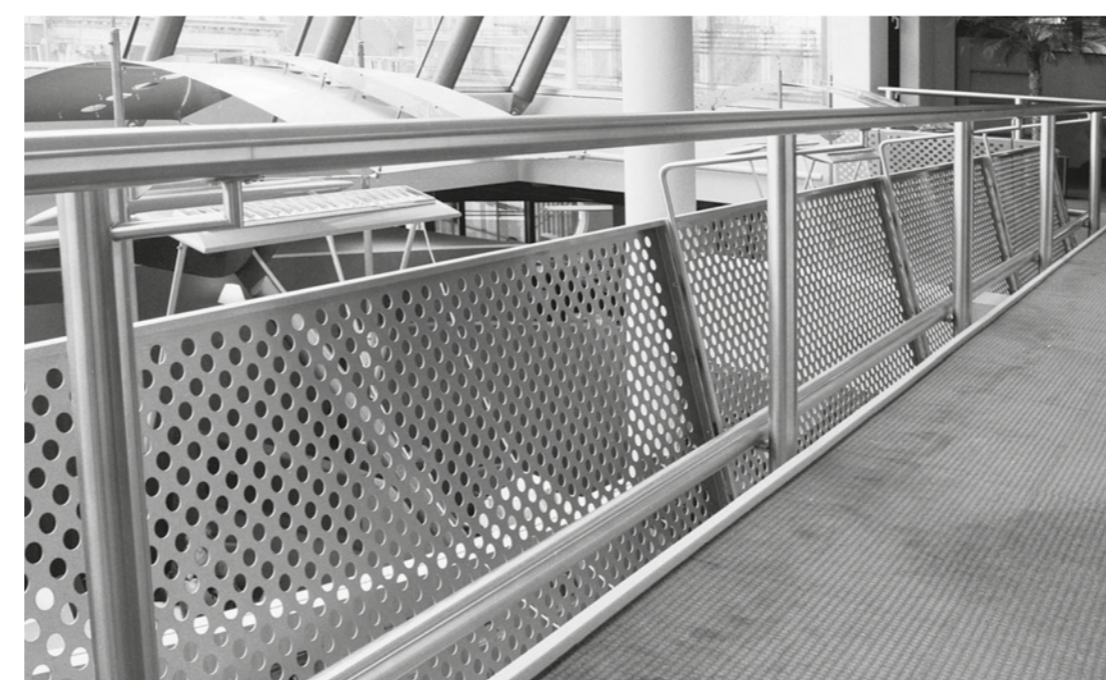

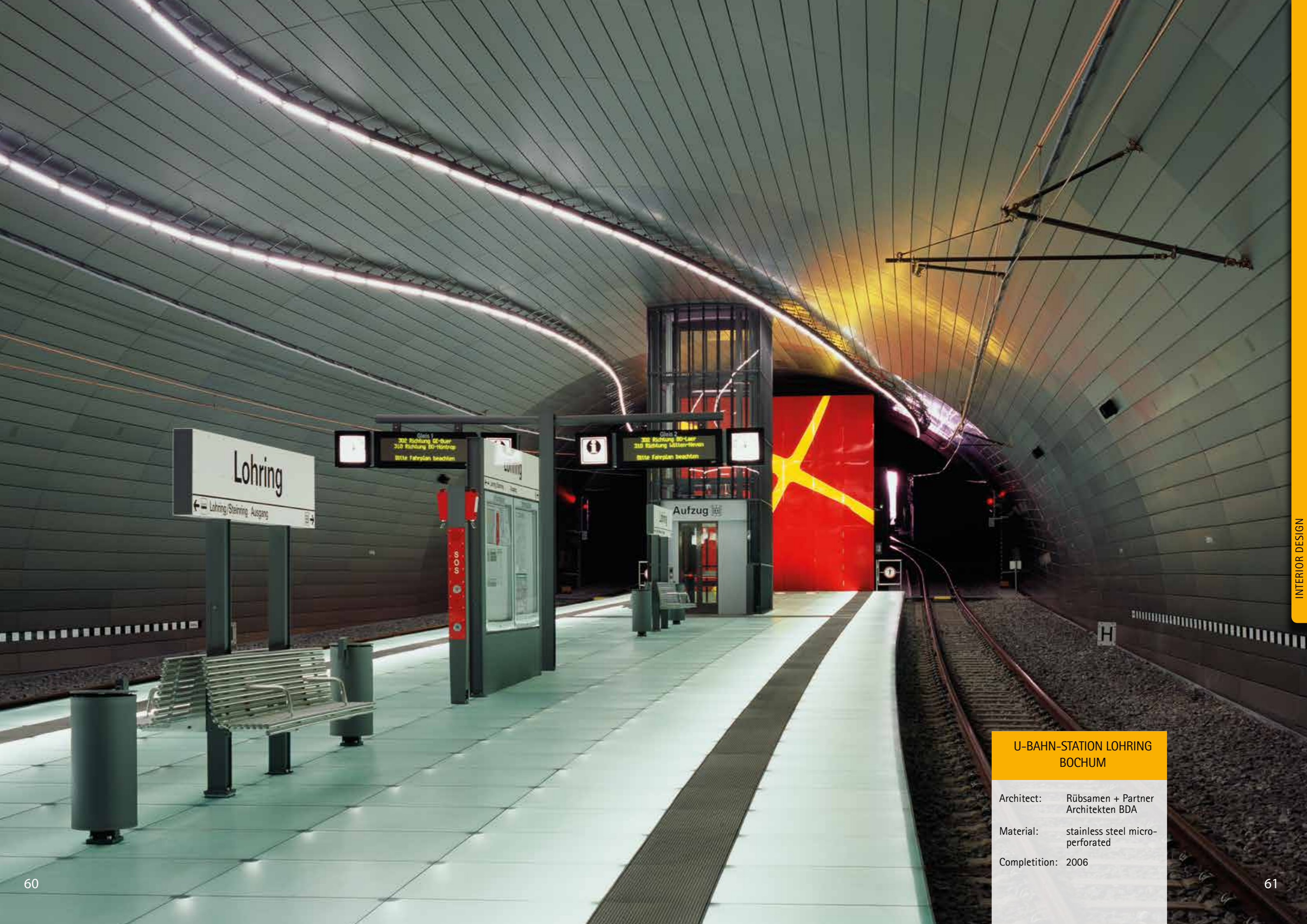

Lohring
← Lohring/Steinring Ausgang →

Gleis 1
302 Richtung GE-Buer
310 Richtung BO-Hofberg
Bitte Fahrplan beachten

Gleis 2
300 Richtung BO-Leer
310 Richtung Lütten-Tenen
Bitte Fahrplan beachten

Aufzug

U-BAHN-STATION LOHRING
BOCHUM

Architect: Rübsamen + Partner
Architekten BDA
Material: stainless steel micro-
perforated
Completion: 2006



MARKTHALLE ROTTERDAM

Architect: MVRDV, Rotterdam
Material: perforated aluminium sheet
digital picture print
Completion: 2016





DESIGN UND FUNKTIONALITÄT
MIT LOCHBLECH

Sichtschutz und Balkone



Weitere Einsatzbereiche für Lochblechprodukte bieten sich im Bereich der Balkongestaltung und des Sichtschutzes. Das Lochmuster ist frei zu gestalten und wird auf Wunsch des Kunden hergestellt. Die Farbauswahl ist vielfältig und kann je nach Material eloxiert oder pulverbeschichtet ausgeführt werden. Im Balkonbereich wird ein Sichtschutz trotz einer großen offenen Fläche erreicht. Klassische Elemente ebenso wie florale, technische oder fotorealistic Motive können realisiert werden.

Qualität, Langlebigkeit und Nachhaltigkeit stehen bei unseren Produkten im Vordergrund.

Gerne beraten wir Sie bei der Gestaltung. Architekten und Endkunden sind uns gleichermaßen willkommen.

Further application areas for perforated sheet metal products are in the area of balcony design and privacy protection.

The perforated pattern can be freely designed and is produced at the customer's request. The choice of colours is varied and can be anodised or powder-coated depending on the material. In the balcony area, privacy protection is achieved despite a large open area. Classic elements as well as floral, technical or photorealistic forms can be realised.

Quality, longevity and sustainability are the main features of our products.

We will be happy to advise you on the design. Architects and end customers are equally welcome.

**Unterkonstruktionssystem
VECO®-A-1010**

Unterkonstruktion: vertikale Aluminium-
Unterkonstruktion
mit L-Profilen
Befestigungsart: sichtbar genietet

Bauteile der Unterkonstruktion:

Pos.	Bezeichnung
1	Wandhalter-Festpunkt
2	Wandhalter-Gleitpunkt
3	Thermostop
4	Verankerungsmittel
5	Bohrschraube
6	Vertikales Tragprofil L-Profil 50/40/2

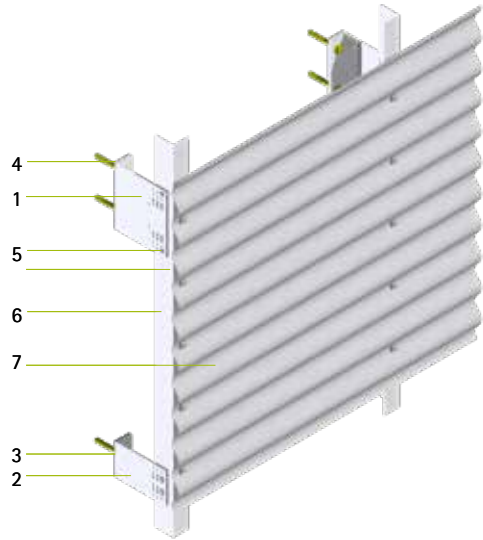

**Substructure system
VECO®-A-1010**

Substructure: Vertical aluminium
substructure
with L-profiles
Type of fastening: Visible, by bolts

Substructure components:

Pos.	Description
1	Bracket fix point
2	Bracket slide point
3	Thermo element
4	Anchors
5	Self-drilling screws
6	Vertical profile L-profile 50/40/2

**Unterkonstruktionssystem
VECO®-G-1000**

Unterkonstruktion: horizontale Galvalume®-
Unterkonstruktion
mit L-Profilen

Bauteile der Unterkonstruktion:

Pos.	Bezeichnung
1	Wandhalter
3	Verankerungsmittel
4	Bohrschraube
5	Horizontales Tragprofil
6	Fassadenbekleidung

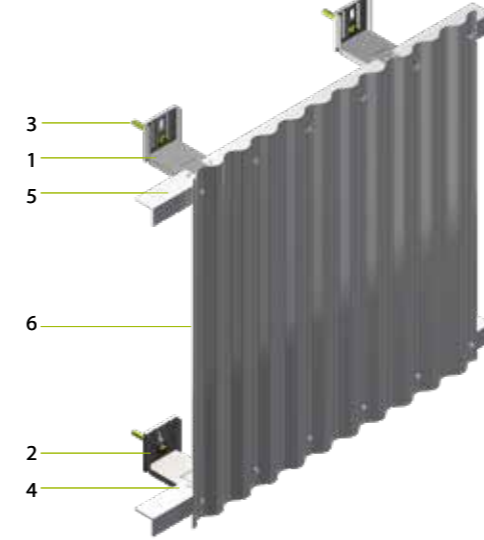

**Substructure system
VECO®-G-1000**

Substructure: Horizontal Galvalume®
substructure
with L-profiles
Type of fastening: Fixation by bolts

Substructure components:

Pos.	Description
1	Bracket
2	Thermo element
3	Anchors
4	Self-drilling screws
5	Horizontal profile
6	Cladding

**Unterkonstruktionssystem
VECO®-A-1011**

Unterkonstruktion: vertikale Aluminium-
Unterkonstruktion
mit L- und T-Profilen
Befestigungsart: sichtbar genietet

Bauteile der Unterkonstruktion:

Pos.	Bezeichnung
1	Wandhalter-Festpunkt
2	Wandhalter-Gleitpunkt
3	Thermostop
4	Verankerungsmittel
5	Bohrschraube
6	Vertikales Tragprofil
7	Fassadenbekleidung

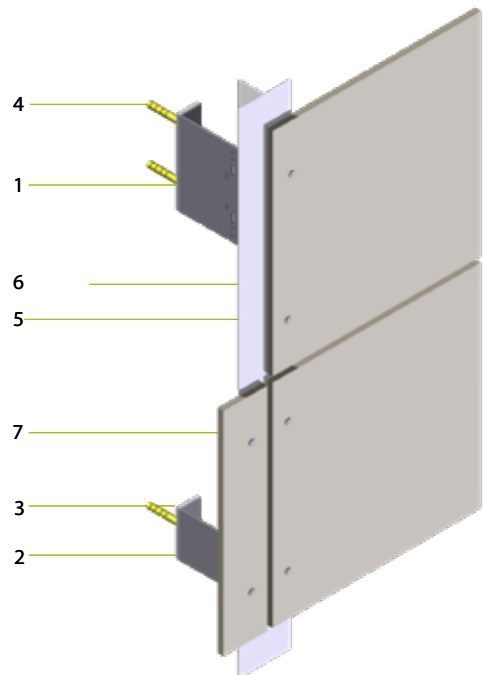

**Substructure system
VECO®-A-1011**

Substructure: Vertical aluminium
substructure
with L- and T-profiles
Type of fastening: Visible, by bolts

Substructure components:

Pos.	Description
1	Bracket fix point
2	Bracket slide point
3	Thermo element
4	Anchors
5	Self-drilling screws
6	Vertical profile
7	Cladding

**Unterkonstruktionssystem
VECO®-A-3010**

Unterkonstruktion: vertikale Aluminium-
Unterkonstruktion mit
vertikalem Grundprofil
für Schiebolzen
Befestigungsart: eingehangen auf
Metallbolzen

Bauteile der Unterkonstruktion:

Pos.	Bezeichnung
1	Wandhalter-Festpunkt
2	Wandhalter-Gleitpunkt
3	Thermostop
4	Verankerungsmittel
5	Bohrschraube
6	Vertikales Tragprofil, Schieber mit Bolzen, kunststoffummantelt
7	

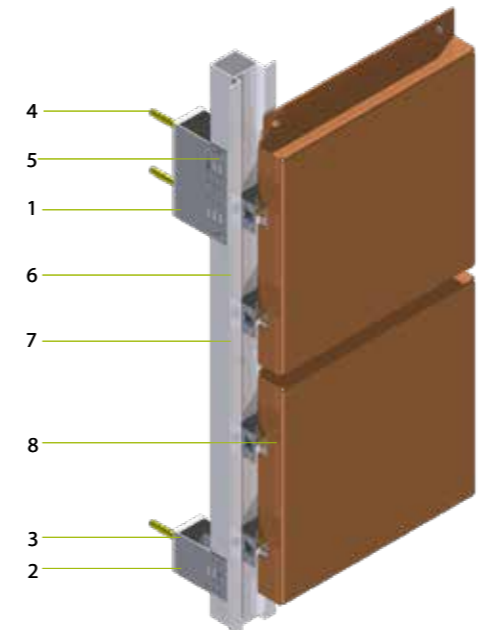

**Substructure system
VECO®-A-3010**

Substructure: Vertical aluminium
substructure
with vertical base profile
or sliding bolts
Type of fastening: Suspended on
metal bolts

Substructure components:

Pos.	Description
1	Bracket fix point
2	Bracket slide point
3	Thermo element
4	Anchors
5	Self-drilling screws
6	Vertical profile, Slider with bolts, polymer coated
7	

Mensch und Maschine auf höchstem Niveau

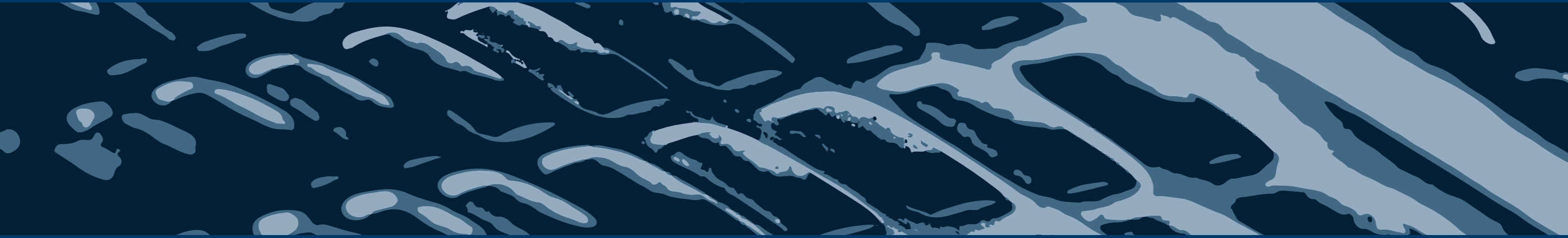



Dillinger Fabrik Gelochter Bleche GmbH
Franz-Méguin-Straße 20 | D-66763 Dillingen

Telefon +49 68 31 / 70 03-0
Fax +49 68 31 / 70 40-76
E-Mail info@dfgb.de